

Art.-Nr. / Item No.	Farbe / Colour
44994	schwarz / black
44978	weiß / white

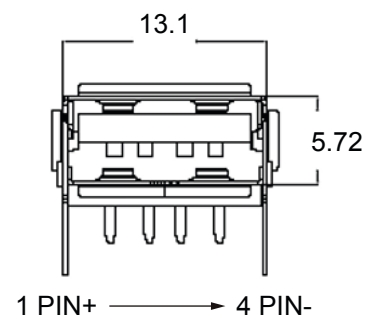
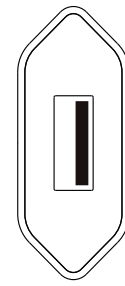
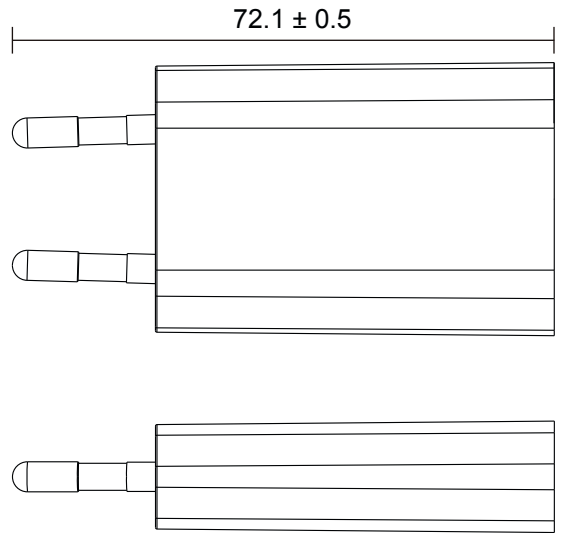
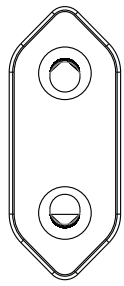
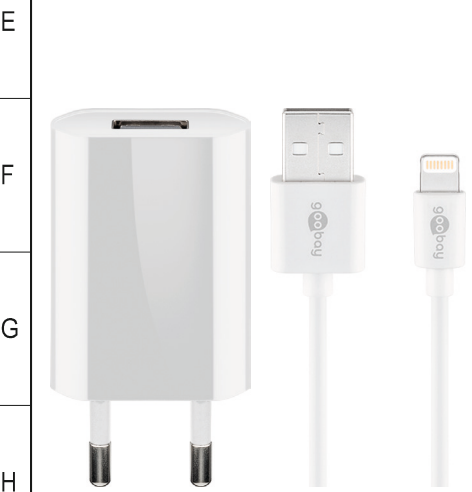
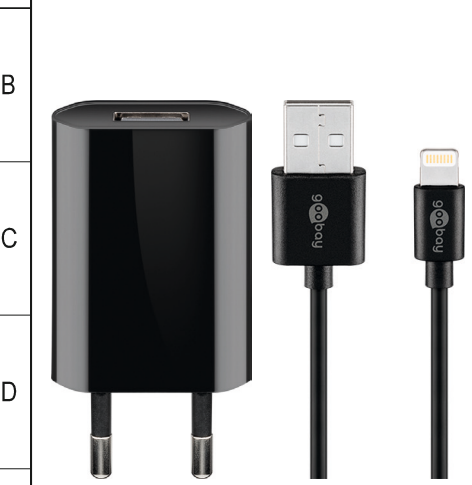

**Apple Lightning Ladeset 1 A**

- Set aus Ladegerät und Apple Lightning Kabel

**Ladegerät**

**Anschlüsse:** Eurostecker (Typ C, CEE 7/16),  
USB 2.0-Buchse (Typ A)

**Eingang:** 100-240 V ~, 50/60 Hz, 0,2 A

**Ausgang:** 5,0 V =, 1,0 A, 5,0 W max.

**Ø Effizienz im Betrieb:** 76,1 %

**Leistungsaufnahme bei Nulllast:** 0,06 W

**Gewicht:** 24,5 g

**Kabel**

**Anschlüsse:** USB 2.0-Stecker (Typ A),  
Apple Lightning Stecker

**Max. Datenübertragungsrate:** 480 Mbit/s

**Kabellänge:** 1 m

**Gewicht:** 19 g

**Apple Lightning charger set 1 A**

- Set with charger and Apple Lightning cable

**Charger**

**Connectors:** Euro plug (Typ C, CEE 7/16),  
USB 2.0 jack (type A)

**Input:** 100-240 V ~, 50/60 Hz, 0.2 A

**Output:** 5.0 V =, 1.0 A, 5.0 W max.

**Ø Active efficiency:** 76.1 %

**Power consumption at no load:** 0.06 W

**Weight:** 24.5 g

**Cable**

**Connectors:** USB 2.0 plug (type A),  
Apple Lightning plug

**Max. Data transmission rate:** 480 Mbit/s

**Cable length:** 1 m

**Weight:** 19 g

<b>Änderungen</b>			Datum	Name	Bezeichnung		Blatt
Datum	Name	gez.:	28.04.2021	aw	TRA SET Lightning 1xUSB 5W/ 1A Slim 1,0m PL		1/2
		gepr.:	28.04.2021	aw	Zeichnungs-Nr.:	von	
		Norm:	Änderungen vorbehalten / Subject to change		44994, 44978		

P1  
USB-A

12 ± 0.3

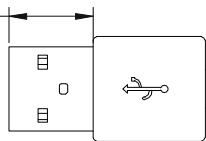

50 ± 5

1000 mm

P2  
Lightning-USB

6.47 - 6.75

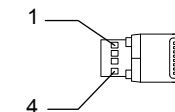
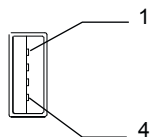
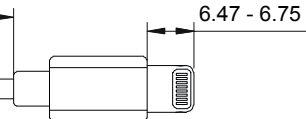

Pin-Belegung / Pin assignment

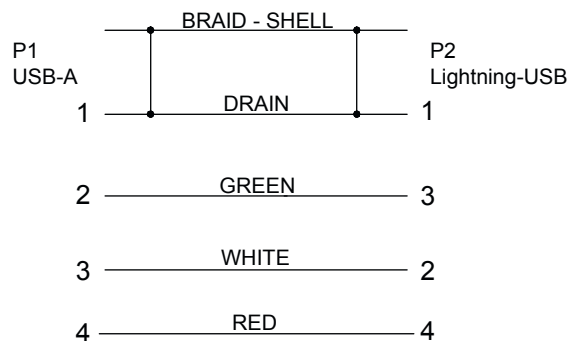

Aderquerschnitt / Wire cross section

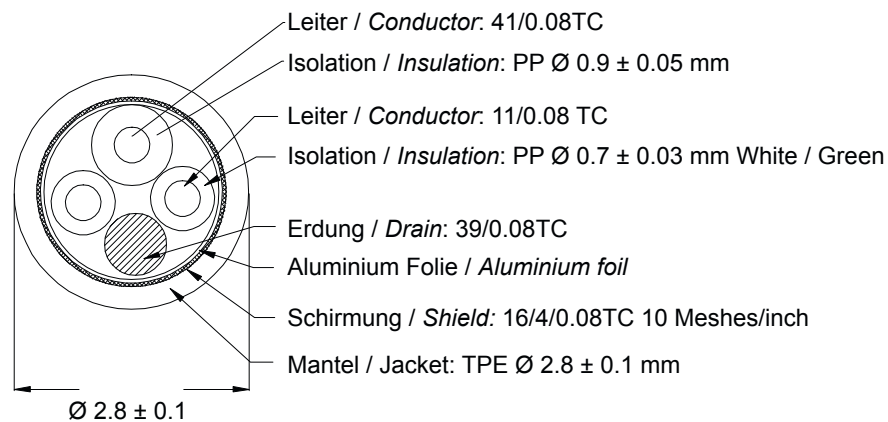

Änderungen

Datum	Name	gez.:	Datum	Name
		gez.:	28.04.2021	aw
		gepr.:	28.04.2021	aw
		Norm:		
Änderungen vorbehalten / Subject to change				

Bezeichnung

TRA SET Lightning 1xUSB 5W/  
1A Slim 1,0m PL



Blatt

2/2

Zeichnungs-Nr.:

44994, 44978

von